



DT100

445-080 JANUARY 2012-REVISED MAY 2017

**IMAGENEX MODEL DT100
MULTIBEAM PROFILING SONAR**



Patent Pending

Specifications subject to
change without notice



Copyright © 2012 - 2019
Imagenex Technology Corp.

HARDWARE SPECIFICATIONS:	
FREQUENCY	240 kHz
SWATH WIDTH (nominal beam geometry)	Transmit: 120° x 3° Receive: 120° x 3°
EFFECTIVE BEAM WIDTHS	Narrow: 0.75° Medium: 1.5° Wide: 3°
NUMBER OF BEAMS	Default: 480 Selectable: 240, 120
RANGE RESOLUTION: SCREEN OUTPUT	0.2% of range 0.02% of range
RANGE	60 m (197') water depth 100 m (328') slant range
MIN. DETECTABLE RANGE	0.5 m (1.6') below transducer
MAX. OPERATING DEPTH (Submersion depth)	100 m (328')
INTERFACE TO PC	Ethernet (10 base-T) using TCP/IP
MAX. CABLE LENGTH	100 m (328') on CAT5-e, longer cable runs possible with additional hardware
CONNECTOR	Underwater wet-mateable 8 conductor
POWER SUPPLY (sonar head only)	22 - 32 VDC at less than 10 Watts
DIMENSIONS	162 mm (6.38") L x 117 mm (4.62") H x 92 mm (3.63") W
WEIGHT: In Air	8 kg (18 lbs) for Stainless Steel or ~2.7 kg (~6 lbs) for Delrin
MATERIALS	316 Stainless Steel, Epoxy, Stainless Steel connector Also available in Polyoxymethylene (i.e. Delrin) housing
POWER SUPPLY/ TIMING BOX: DT100 Sensor Interface Relay (DT100 SIR)	2 port Ethernet switch (DT100 PC and Survey PC) Interfaces to: DT100 (1 or 2 units) GNSS (GPS) Motion Reference Unit Gyro / Heading Sensor Sound Velocity Sensor 100 – 240 VAC or 12 – 36 VDC input range Dimensions: 394 mm (15.5") x 325 mm (12.8") x 87 mm (3.5")
MAX. PING RATE	20 Hz

SOFTWARE SPECIFICATIONS:	DT100.exe or DT100_SIR.exe (for SIR)	
WINDOWS™ OPERATING SYSTEM	Windows™ XP, Vista, 7, 8, 10	
DISPLAY MODES	Sector, Linear, Perspective, Profile, Beam Test	
PERSISTENCE (TRAIL)	1 – 300 seconds	
RANGE SCALES	5 m, 10 m, 20 m, 30 m, 40 m, 50 m, 60 m, 80 m, 100 m	
SECTOR SIZES	30°, 60°, 90°, 120°	
FILE FORMAT:		For SIR:
RAW DATA	(filename).837	(filename).D1R
PROFILE POINT	(filename).83P	(filename).D1P
RECOMMENDED MINIMUM COMPUTER REQUIREMENTS:	2 GHz Pentium 4 256 MB RAM 20 GB Hard Disk 1024 x 768 screen resolution	

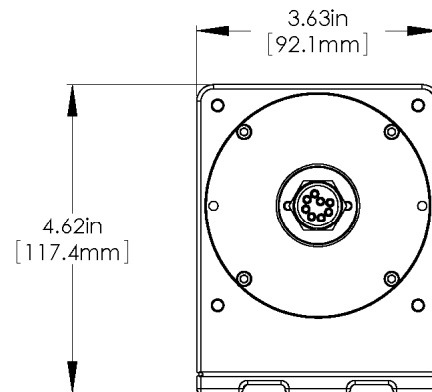
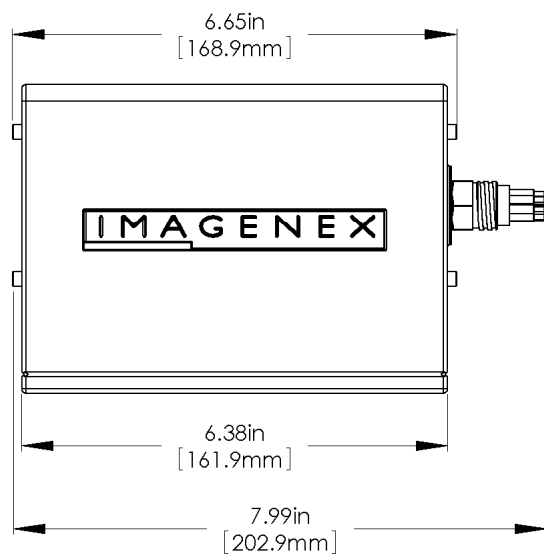
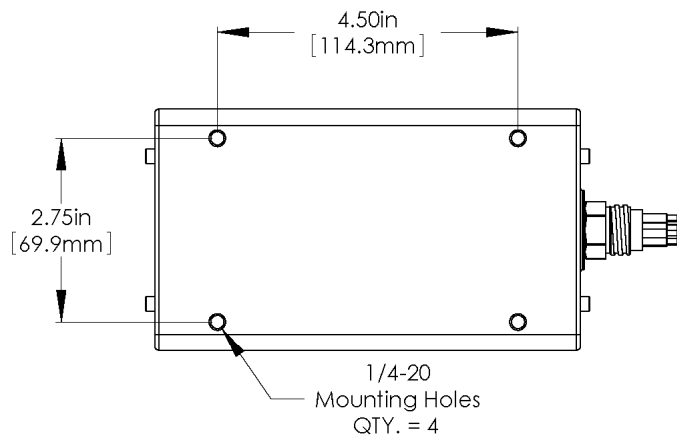

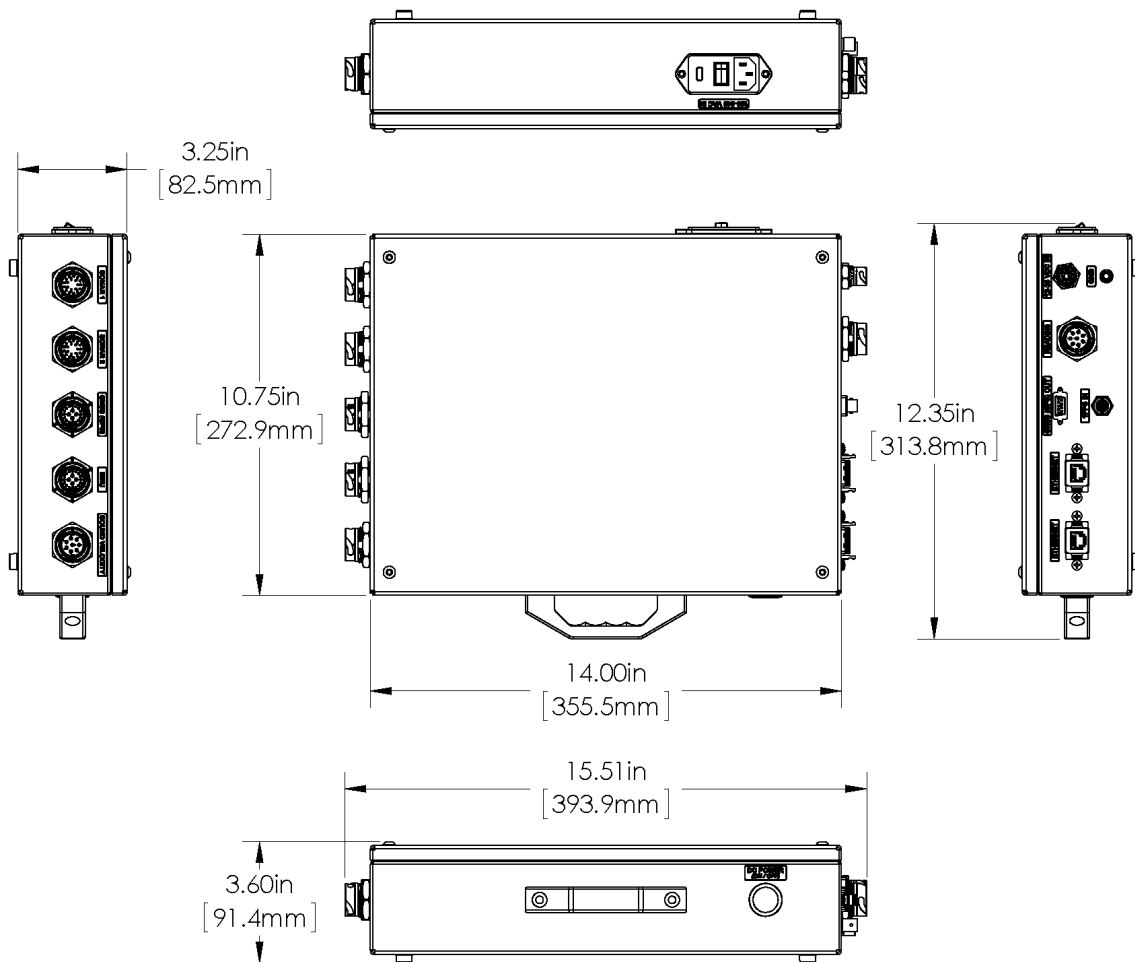

ORDERING INFORMATION:		
100 m Stainless Steel UNIT	Standard	837B-000-440
100 m Delrin UNIT	Standard	837B-000-441
Sensor Interface Relay box (DT100 SIR)	Option	837-000-007
IP Address*	Option	-020
Dual Head Software	Option	-024

*Note: Standard IP Address is 192.168.0.2
 A different IP Address may be specified upon ordering.

Product and company names listed are trademarks or trade names of their respective companies.