



## miniIPS2 and 2e Operating Manual



Document ID      MANUAL-1827945207-1 | issue: 1.4  
Date:              November 2021

This confidential document was prepared by the staff of Valeport Limited, the Company, and is the property of the Company, which also owns the copyright therein. All rights conferred by the law of the copyright and by virtue of international copyright conventions are reserved to the Company. This document must not be copied, reprinted or reproduced in any material form, either wholly or in part, and the contents of this document, and any method or technique available there from, must not be disclosed to any other person whatsoever without the prior written consent of the Company.

© 2021 Valeport Ltd

Valeport Ltd  
St Peter's Quay  
Totnes TQ9 5EW  
United Kingdom

Phone: +44 1803 869292  
email: sales@valeport.co.uk  
Web: www.valeport.co.uk

As part of our policy of continuous development, we reserve the right to alter, without prior notice, all specifications, designs, prices and conditions of supply for all our equipment

# Contents

- 1 Introduction.....1
- 2 Sensors.....2
  - 2.1 Pressure Sensor .....2
  - 2.2 Interchangeable Pressure Sensor Modules .....2
- 3 Physical Characteristics .....4
  - 3.1 Materials .....4
  - 3.2 Dimensions - minilPS 2 .....4
  - 3.3 Dimensions - minilPS 2e .....4
- 4 Communications.....5
  - 4.1 Introduction .....5
  - 4.2 Serial Comms - RS232 and RS485 .....5
  - 4.3 Ethernet .....6
    - 4.3.1 Setting up Ethernet Connectivity .....6
    - 4.3.2 Operation with DataLog x2 .....9
    - 4.3.3 Instrument Communications Setup .....9
- 5 Setting Up the minilPS2 .....11
  - 5.1 Start / Stop .....11
    - 5.1.1 Output Last Measured Reading.....11
  - 5.2 Welcome Message .....12
  - 5.3 Warning Message.....13
  - 5.4 Error Flag .....13
  - 5.5 Sampling Modes .....14
  - 5.6 Units .....15
    - 5.6.1 Commands .....15
  - 5.7 Pressure Tare .....16
  - 5.8 Set Latitude.....17
  - 5.9 Standard Set Up .....17
  - 5.10 Information #Codes .....18
- 6 Data Output Formats.....19
  - 6.1 Data String Formatting .....19
  - 6.2 Format: Valeport CSV .....19
  - 6.3 Format: Valeport (Standard).....20
  - 6.4 Format: Valeport NMEA (\$PIPS).....20
  - 6.5 Format: Valeport NMEA (\$PVIPS2) .....21
  - 6.6 Format: CSV .....21
  - 6.7 Format: Digiquartz .....22
  - 6.8 Format: Digiquartz CDL.....22
  - 6.9 Format: Hypack .....22
  - 6.10 Format: Impact SubSea.....23
  - 6.11 Modbus RTU over RS485 .....23
- 7 Electrical .....24
  - 7.1 Power - minilPS 2 .....24
  - 7.2 Power - minilPS 2e .....24
  - 7.3 Wiring Information.....24
    - 7.3.1 Serial Connection.....24

|       |                                                 |    |
|-------|-------------------------------------------------|----|
| 7.3.2 | Ethernet Connection .....                       | 24 |
| 8     | Software - Valeport Configure App .....         | 26 |
| 8.1   | Interface the instrument.....                   | 26 |
| 8.1.1 | Valeport Configure Without an Instrument .....  | 26 |
| 8.2   | Configure the Instrument.....                   | 27 |
| 9     | Care & Maintenance.....                         | 32 |
| 9.1   | Calibration.....                                | 32 |
| 9.1.1 | Secondary Calibration.....                      | 32 |
| 10    | Ordering and Part Numbers .....                 | 33 |
| 11    | EU Declaration of Conformity - CE Marking ..... | 34 |
| 11.1  | minilPS2.....                                   | 34 |
| 11.2  | minilPS2e.....                                  | 35 |
| 11.3  | Interchangeable Pressure Module .....           | 36 |



# 1 Introduction

The Valeport miniIPS2 and 2e “Intelligent Pressure Sensor” builds on the success of the industry standard miniIPS.

- The miniIPS2 operates over serial comms - RS232 and RS485.
- The miniIPS2e operates over Ethernet (TCP/IP).

Designed to measure water pressure and provide a real time output of that data in a number of formats and units. The miniIPS2 and 2e are fitted with an Interchangeable, depth optimised, pressure sensor allowing the most operationally suitable pressure sensor module to be fitted for the operational water depth. To be used in a variety of subsea applications ROVs, construction survey, monitoring and positioning operations, one of the key development drivers was to provide a cost-effective alternative to the use of resonant quartz pressure sensors. Using the very latest technology in temperature compensated piezo-resistive transducers, the miniIPS2 and 2e offers several advantages over resonant quartz sensors, with similar performance - cost, maintenance and operationally specific pressure ratings.

- Interchangeable pressure sensor module
  - Pressure ranges from 10 to 600Bar (approx. 100m to 6,000m water)
  - Titanium diaphragm pressure sensor
    - No external diaphragms, oil reservoir or oil-filled tubes
  - Long term calibration stability
  - 2 year recommended recalibration cycle
- Titanium housing
- RS232 or addressable RS485 data output
- ASCII and Modbus RTU output protocols
- Choice of calibrated data formats
- TEOS 10 seawater properties of water computation for depth calculation
- Choice of sampling modes

## 2 Sensors

### 2.1 Pressure Sensor

The miniIPS2 and 2e are fitted with the following sensors:

- A high accuracy, 0.01% of full scale, temperature compensated piezo-resistive pressure transducer.
- The Pressure Module is interchangeable

|                              |                                                                                            |
|------------------------------|--------------------------------------------------------------------------------------------|
| Sensor Type                  | Strain Gauge                                                                               |
| Range:<br>individual modules | 10, 20, 30, 50, 100, 200, 300, 400 or 600 Bar<br>1 bar is approximately equal to 10m depth |
| Resolution:                  | 0.001                                                                                      |
| Accuracy:                    | ±0.01% of full range                                                                       |
| Response Time:               | 1 millisecond                                                                              |

### 2.2 Interchangeable Pressure Sensor Modules

The Interchangeable Pressure Sensor Modules can be swapped to best suit the operational depth of the project. The accuracy of the sensor is a factor of the full-scale capability of the sensor - 0.01% and not the measured pressure. A 600 Bar module will offer the same ±0.60m accuracy at 6000m as it will at 250m while a correctly selected 30 Bar Pressure Module, for an operation at 250m, will provide an accuracy ± 0.03m

| Bar | Maximum Operational Depth<br>(metres) | Accuracy (0.01%)<br>(± metres) |
|-----|---------------------------------------|--------------------------------|
| 10  | 100                                   | 0.01                           |
| 20  | 200                                   | 0.02                           |
| 30  | 300                                   | 0.03                           |
| 50  | 500                                   | 0.05                           |
| 100 | 1000                                  | 0.10                           |
| 200 | 2000                                  | 0.20                           |
| 300 | 3000                                  | 0.30                           |
| 400 | 4000                                  | 0.40                           |
| 600 | 6000                                  | 0.60                           |

Prior to changing out a Pressure Module the mini IPS 2 or 2e should be thoroughly rinsed in fresh water and dried.

A Pressure Module should ideally be changed in dry lab conditions but if this is not possible every effort must be made to keep water out of the module socket. Check the module and socket for any water and if found dry everything thoroughly before fitting. If water does get into the socket it could cause the connector to corrode.

A special tool is provided to unscrew the fitted module and screw its replacement securely into place. Never use excessive force.

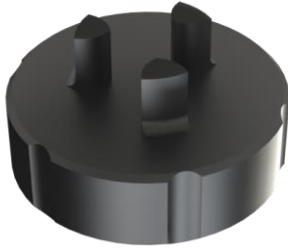

The three prongs should be carefully inserted into the lock screw cap of the Pressure Module and turned counter-clockwise (when looking directly at the module) to loosen it. Keep turning until the Pressure Module gently pops out of the socket. The tool will engage with the Pressure Module and allow you to very gentle pull if required.

Before fitting a replacement Pressure Module check all surfaces for wear - especially the lock screw cap. Check the O rings are clean and free of any debris, wear or damage. There is no need to grease the O rings. The closing action of the system does not rely on surfaces sliding over one another and grease might attract debris that would compromise the seal.

The replacement Pressure Module should be placed into the socket with the connector approximately lined up with its pair. Fine adjustment is achieved by the shape of the module housing in the socket.

Engage the screw cap into the threads of the socket and then use the tool to tighten the Pressure Module into place. The module should be screwed down until the shoulder of the lock screw cap is in line with the shoulder of the titanium end-cap as shown below:

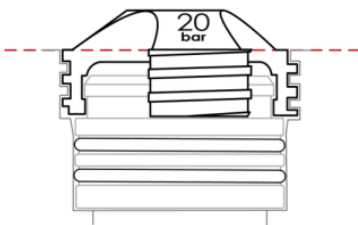

Do not over tighten.

Inside the transit case an additional transit case is provide for the Pressure Module to all it to be sent off for calibration without the need to send the whole instrument.

### 3 Physical Characteristics

#### 3.1 Materials

|                      |                                                                                                                                                          |
|----------------------|----------------------------------------------------------------------------------------------------------------------------------------------------------|
| Housing & Bulkhead:  | Titanium                                                                                                                                                 |
| Screw Cap:           | Acetal                                                                                                                                                   |
| Transducer Diaphragm | Titanium                                                                                                                                                 |
| Connector:           | minilPS2: Standard is SubConn type MCBH6F (titanium)<br>minilPS2e: Standard is SubConn type DBH13F (titanium)<br>Alternatives may be supplied on request |
| Weight:              | <0.75kg (in air)                                                                                                                                         |

#### 3.2 Dimensions - minilPS 2

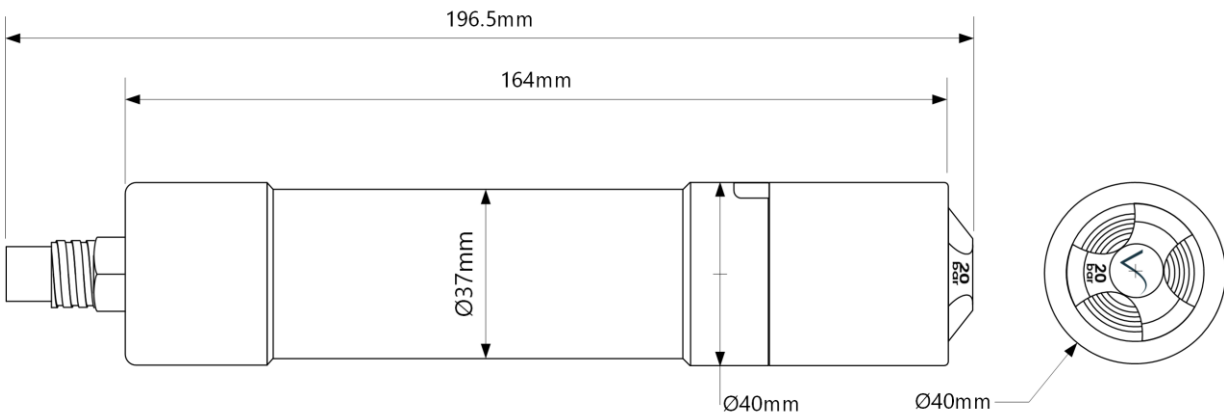

#### 3.3 Dimensions - minilPS 2e

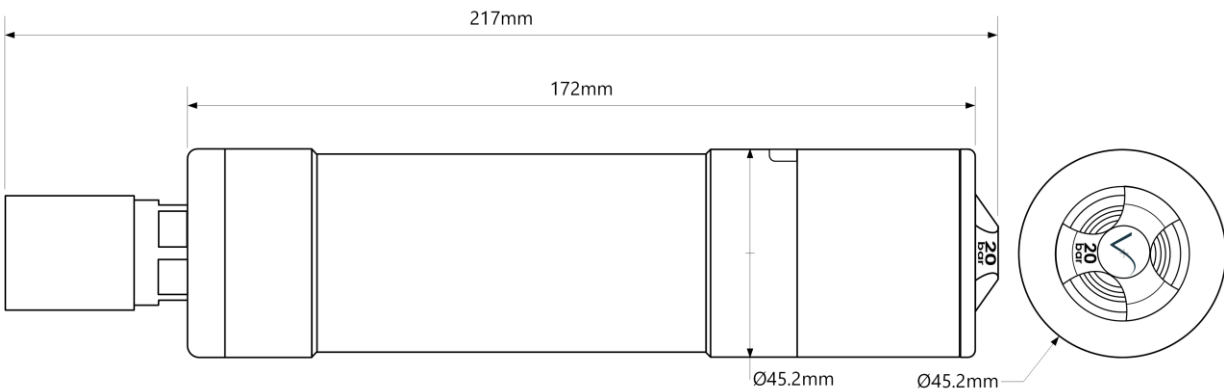



## 4 Communications

### 4.1 Introduction

Control of the miniIPS2 and 2e is achieved through the use of “# codes”, as described in the sections below.

All commands must be “sent” by pressing the Enter key with the exception of the single ‘#’ character required to enter set up mode

### 4.2 Serial Comms - RS232 and RS485

miniIPS2 is fitted with both RS232 and RS485 communications as standard. RS485 is enabled by grounding a pin in the communications lead (refer to [Wiring Section](#)).

Protocol is 8 data bits, 1 stop bit, no parity, no flow control.

Baud rate is factory set to 115200. User may choose between 1200, 2400, 4800, 9600, 19200, 38400, 57600 and 115200.

Fast data rates and longer data string outputs may not be possible with low baud rates

## 4.3 Ethernet

The miniIPS2e is fitted with a Transmission Control Protocol/Internet Protocol (TCP/IP) Ethernet module set up in Dynamic Host Configuration Protocol (DHCP). This means the instrument will automatically be assigned a IP address. Depending on how your router works, it should go back to that IP address each time it is interfaced although this is not guaranteed unless you provide it with a fixed IP in the router configuration.

### 4.3.1 Setting up Ethernet Connectivity

The miniIPS2e has a Lantronix Ethernet module that will need to be configured. You can download the Lantronix Device Installer software from [here](#).

Connect the miniIPS2e to the network and run the software. If the device is not found after a few moments press Search, top left

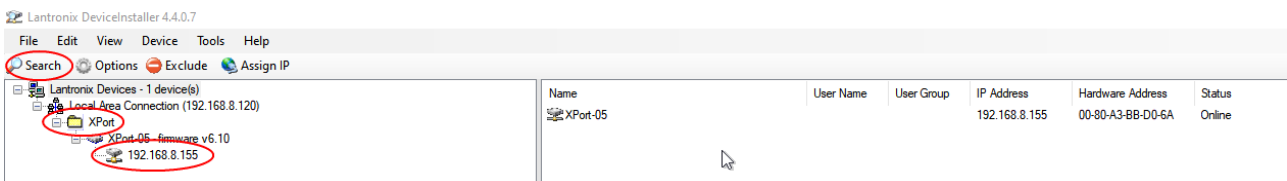

Once the module has been found click on XPort to reveal the IP address - in the example above: 192.168.8.155

Click on the IP Address in the left hand panel to reveal more information in the right hand panel

Select Web Configuration

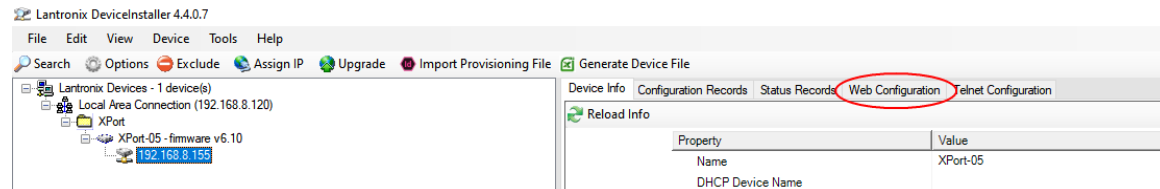

Select the green arrow to reveal the password entry dialogue

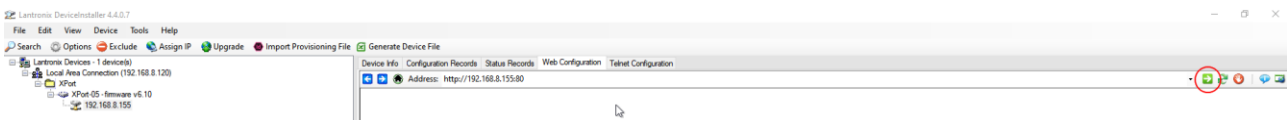

Do not enter a Username or Password - simply select OK



- Select Connection, ensure settings are similar to below

do not select or accept a Local Port number 23  
Local Port number 23 is reserved for TelNet

- Select Apply Settings
- Perform a new search after the settings have been completed.

The screenshot shows the 'Connection Settings' page for 'Channel 1' in the XPort LANTRONIX web interface. The left sidebar contains a navigation menu with 'Connection' and 'Apply Settings' highlighted in red circles. The main content area is divided into several sections:

- Channel 1**:
  - Connect Protocol**: Protocol: TCP (dropdown)
  - Connect Mode**:
    - Passive Connection:**
      - Accept Incoming: Yes (dropdown)
      - Password Required:  Yes  No
      - Password: [text input]
      - Modem Escape Sequence Pass Through:  Yes  No
    - Active Connection:**
      - Active Connect: None (dropdown)
      - Start Character: 0x0D (in Hex)
      - Modem Mode: None (dropdown)
      - Show IP Address After RING:  Yes  No
  - Endpoint Configuration:**
    - Local Port: 10001 (text input, circled in red)
    - Remote Port: 0 (text input)
    - Auto increment Local Port for active connect:
    - Remote Host: 0.0.0.0 (text input)
  - Common Options:**
    - Telnet Com Port Cntrl: Disable (dropdown)
    - Connect Response: None (dropdown)
    - Terminal Name: [text input]
    - Use Hostlist:  Yes  No
    - LED: Blink (dropdown)
  - Disconnect Mode:**
    - On Mdm\_Ctrl\_In Drop:  Yes  No
    - Hard Disconnect:  Yes  No
    - Check EOT(Ctrl-D):  Yes  No
    - Inactivity Timeout: 0 : 0 (mins : secs)

An 'OK' button is located at the bottom of the settings area.

- Select Serial settings, Set Baud Rate on Channel 1 to 115200
- Apply settings
- Perform a new search after the settings have been completed and applied.

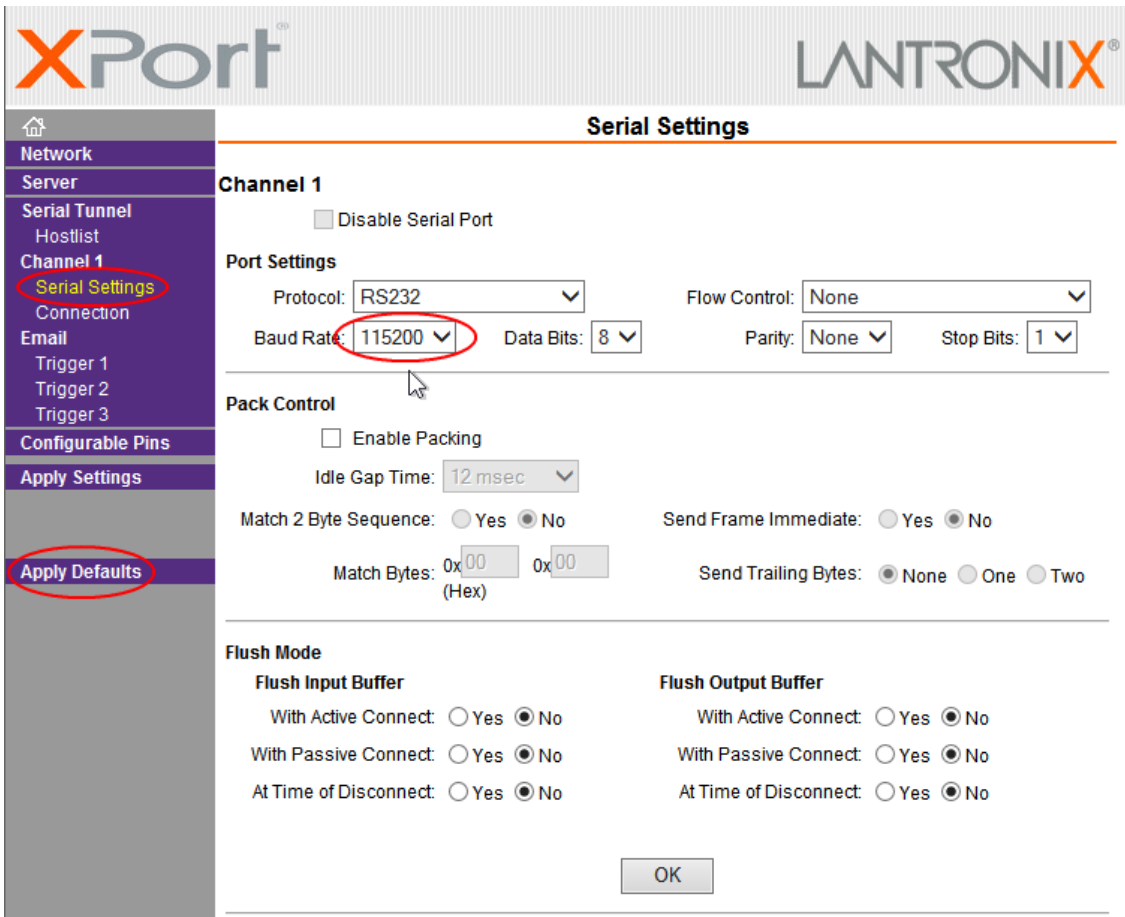

### 4.3.1.1 Fixed IP

To set a fixed IP address for the unit follow the wizard in the Lantronix App

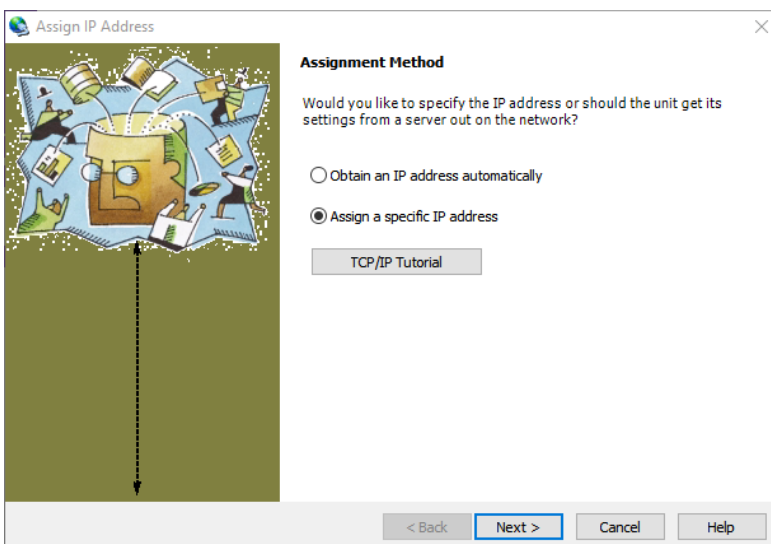

### 4.3.2 Operation with DataLog x2

Load the latest version of Valeport's configuration software DataLog x2. It can be downloaded from [www.valeport.co.uk](http://www.valeport.co.uk) - search for miniIPS2 then look for the software section towards the bottom of the page.

Setup the TCP Client windows to match the data from the Lantronix Device Installer. The instrument can be configured using the software or with individual #commands as required.

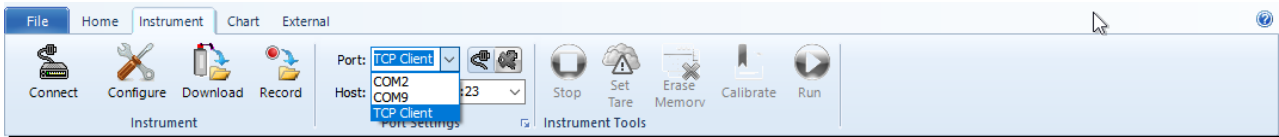

### 4.3.3 Instrument Communications Setup

The following # commands need to be set as required to achieve the communications scenario required

| Code        | Description                                                                                                                                                                                                                                                                                                                   |
|-------------|-------------------------------------------------------------------------------------------------------------------------------------------------------------------------------------------------------------------------------------------------------------------------------------------------------------------------------|
| #001;n      | Set RS485 address to any number from 01 to 99 leading 0 required for address numbers 1 to 9                                                                                                                                                                                                                                   |
| #002        | Read current address                                                                                                                                                                                                                                                                                                          |
| #005;n      | Set address mode On   Off where n =<br>#005;0 (Off)<br>#005;1 (On)<br>In address mode, the miniIPS2 and 2e will only respond to commands prefixed by its address, or the global address "00"<br>Example:<br>03:#028<br>miniIPS2 address "03", begin sampling<br>Example:<br>00:#028<br>All miniIPS2 addresses, begin sampling |
| #006        | Read Address Mode activation status                                                                                                                                                                                                                                                                                           |
| #059;xxxxxx | Set the miniIPS2 and 2e baud rate as required<br>Available baud rates are 1200, 2400, 4800, 9600, 19200, 38400, 57600, 115200<br>Example: #059;9600                                                                                                                                                                           |
| #352,n      | Enable   Disable # on Modbus - interrupts the instrument with a serial # if in Modbus mode<br>#352;0 (disable)<br>#352;1 (enable)                                                                                                                                                                                             |
| #353        | Read # on Modbus activation status                                                                                                                                                                                                                                                                                            |
| #700; n;n   | Enables Modbus communications mode with parity on or off<br>Once entered into Modbus mode the miniIPS2 or 2e will begin to measure on the measurement cycle.<br>#700;0;0 - Modbus disabled<br>#700;0;1 - Modbus disabled<br>#700;1;0 - Modbus No Parity<br>#700;1;1 - Modbus Even Parity                                      |
|             | this function is password protected                                                                                                                                                                                                                                                                                           |
| #701        | Read Modbus activation status                                                                                                                                                                                                                                                                                                 |

| Code     | Description                                                                                                                                                                                       |
|----------|---------------------------------------------------------------------------------------------------------------------------------------------------------------------------------------------------|
| #702;nnn | Set RS485 address to any number from 01 to 247<br><div data-bbox="874 275 1417 338" style="border: 1px solid red; padding: 2px; display: inline-block;">this function is password protected</div> |
| #703     | Read current address                                                                                                                                                                              |

## 5 Setting Up the miniIPS2

### 5.1 Start / Stop

When power is applied to the miniIPS, it will immediately begin to operate according to the settings already programmed. The most basic level of Stop / Start control is, therefore, by switching power on and off.

| # Code | Description                                                                                                                                                                                                                                                                                                                                                                                                                                                                                                                                                                                                                                                                                                           |
|--------|-----------------------------------------------------------------------------------------------------------------------------------------------------------------------------------------------------------------------------------------------------------------------------------------------------------------------------------------------------------------------------------------------------------------------------------------------------------------------------------------------------------------------------------------------------------------------------------------------------------------------------------------------------------------------------------------------------------------------|
| #      | <p>When the instrument is running, the miniIPS2 and 2e may be put into set up mode at any time by typing the '#' character followed by the ENTER key. The device will respond with a command prompt '&gt;' and wait the next instruction</p> <p>When interrupted an error is often seen. This is generated due to the &lt;CR&gt;&lt;LF&gt; usually associated with the # and should not be interpreted as a problem with the miniIPS2.</p> <p>A "watchdog" function is in operation within the miniIPS2 and 2e<br/>If the unit is interrupted with the '#' character, and no further command is received for a period of 5 minutes, the sensor will automatically begin sampling data using the existing settings</p> |
| #028   | Starts sampling in the mode set, or takes a single reading if unit is in "Single" sampling mode                                                                                                                                                                                                                                                                                                                                                                                                                                                                                                                                                                                                                       |

#### 5.1.1 Output Last Measured Reading

In order to read the last measured reading the command #015 can be used.

The data is output in the selected units and data telegram format.

## 5.2 Welcome Message

When the miniIPS2 or 2e is put into a run mode (#028), if the welcome message is enabled (#209;1), it will output a welcome message

| Code   | Description                                                                                       |
|--------|---------------------------------------------------------------------------------------------------|
| #209;n | Enable   Disable the Welcome Message<br>#209;0 disables the warning<br>#210;1 enables the warning |
| #210   | Read Welcome Message activation status                                                            |

The message contains the following information

| Field                              | Format                          | Setup Function |
|------------------------------------|---------------------------------|----------------|
| miniIPS2 or 2e Serial Number:      | xxxxxxx                         |                |
| Pressure Transducer Serial Number: | xxxxxxx                         |                |
| PCB Serial Number:                 | xxxxxxxxxxx                     |                |
| Firmware Version:                  | xxxxxxx September 22 2020 11:42 |                |
| Pressure Module Range:             | xxxBar                          |                |
| Operating Mode:                    | x                               | #011           |
| No of Samples:                     | xxx                             | #029           |
| Sampling Rate:                     | xxxHz                           | #003           |
| Output String Format:              | x                               | #013           |
| Calibrated Units:                  | x                               | #018           |
| Tare Enabled:                      | x                               | #007           |
| Tare Value:                        | xxxxxx (in units)               | #009           |
| instrument Address:                | xx                              | #001           |
| Latitude:                          | xx.xxx                          | #135           |
| Primary Cal:                       | 0.xxxe+00,0.yyye+00,1.zzze+00   |                |
| Secondary Cal Enabled:             | 0                               | #038           |
| Secondary Cal:                     | 0.aaae+00,0.bbbe+00,0.ccce+00   |                |



### 5.3 Warning Message

If a Pressure Module is not fitted and the miniIPS2 is deployed, damage can be caused to the instrument. In order to bring this situation to your notice a warning is transmitted on power up and putting the miniIPS2 into run mode: #028 or the watch dog.

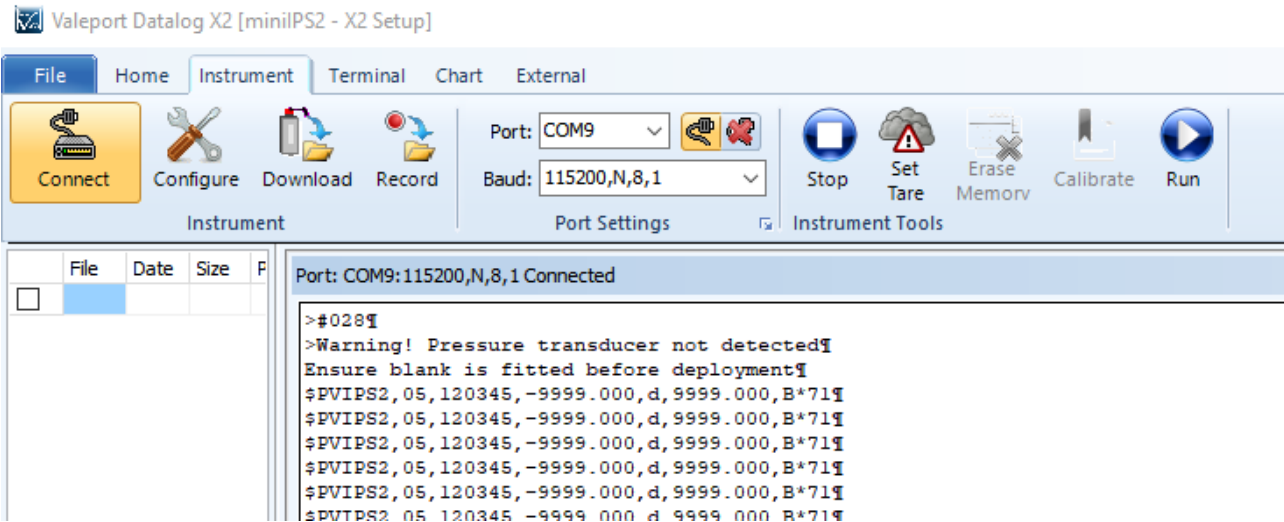

DataLog x2 showing a warning message that a Pressure Module is not fitted

This message can be turned on or off

| Code   | Description                                                                                       |
|--------|---------------------------------------------------------------------------------------------------|
| #220;n | Enable   Disable the Warning Message<br>#220;0 disables the warning<br>#120;1 enables the warning |
| #221   | Reads the Warning Message activation status:                                                      |

### 5.4 Error Flag

| Code   | Description                                                                                                                                                                                  |
|--------|----------------------------------------------------------------------------------------------------------------------------------------------------------------------------------------------|
| #035;n | Sets the value output in the output string when the Pressure   Depth value is in error e.g. missing Pressure Module<br>Where n = a number from -100 000 to 100 000<br>Example:<br>#035;-9999 |
| #036   | Read the Error Flag                                                                                                                                                                          |

## 5.5 Sampling Modes

The miniIPS2 and 2e will operate in a number of different modes:

| Code     | Sampling Mode                                                                                                                                                                                                              | Description                                                                                                                                                                                                                                                                                                                                                                                                              |
|----------|----------------------------------------------------------------------------------------------------------------------------------------------------------------------------------------------------------------------------|--------------------------------------------------------------------------------------------------------------------------------------------------------------------------------------------------------------------------------------------------------------------------------------------------------------------------------------------------------------------------------------------------------------------------|
| #011;0   | HOLD                                                                                                                                                                                                                       | The miniIPS2 or 2e will be powered but make no observations<br><br>#028 will cause an observation to be taken but no data will be output until a #015 command is sent to recover the last observation made                                                                                                                                                                                                               |
| #011;1   | SINGLE                                                                                                                                                                                                                     | Single mode is effectively "Sample on Demand"<br><br>When instructed (#028), the sensor will observe and output the data as a single observation<br><br>Note: If the start-up message is enable it will be generated with each observation                                                                                                                                                                               |
| #011;2   | CONTINUOUS                                                                                                                                                                                                                 | Data is observed and output at a fixed sampling rate from 1 to 100Hz<br>set by #003                                                                                                                                                                                                                                                                                                                                      |
| #011;3   | BURST FIXED AVERAGE                                                                                                                                                                                                        | Data is measured at the sampling rate (#003) for a number of samples (#029)<br>The data set is then averaged before being output as a single observation<br><br>The data set is cleared and a new set of data observed, averaged and output<br><br>An instrument set to update at 32Hz with a dataset size of 32 will output averaged data at 1Hz                                                                        |
| #011;4   | BURST MOVING AVERAGE                                                                                                                                                                                                       | Data is measured at the sampling rate (#003) for a number of samples (#029)<br><br>The data set is then averaged before being output as a single observation<br><br>The oldest observation is dropped and a new one added to the data set<br><br>The data set is then averaged and output as a single observation<br><br>An instrument set to update at 32Hz with a dataset size of 32 will output averaged data at 32Hz |
| #012     | Read the Sampling Mode                                                                                                                                                                                                     |                                                                                                                                                                                                                                                                                                                                                                                                                          |
| #003;nn  | Set the Sampling Rate<br>where xx = 1, 2, 4, 8, 16, 32, 64 or 100Hz<br><br><div style="border: 1px solid red; padding: 5px; text-align: center;">slow baud rates and long output strings can limit the sampling rate</div> |                                                                                                                                                                                                                                                                                                                                                                                                                          |
| #004     | Read Sampling Rate                                                                                                                                                                                                         |                                                                                                                                                                                                                                                                                                                                                                                                                          |
| #029;nnn | Set the number of sample to be averaged                                                                                                                                                                                    |                                                                                                                                                                                                                                                                                                                                                                                                                          |
| #030     | Read the number of samples                                                                                                                                                                                                 |                                                                                                                                                                                                                                                                                                                                                                                                                          |

## 5.6 Units

- The default output units for the miniIPS2 and 2e are deci-Bar (dBar), equivalent to 0.1 Bar, or approximately 1m of seawater
- The miniIPS2 and 2e can also output pressure in a number of different units
- It is also possible to present the data in units of metres or feet of seawater
  - calculated using the TEOS 10 Simple Pressure / Depth relationship, which assumes “standard” water density. A Latitude is required - see [Set Latitude](#)

### 5.6.1 Commands

| # Code | Description                                                                                                                                                                                                                                                                                     |
|--------|-------------------------------------------------------------------------------------------------------------------------------------------------------------------------------------------------------------------------------------------------------------------------------------------------|
| #018;n | Set calibrated units as follows, where n = 1 to 6<br>1 = mBar (m)<br>2 = dBar (d)<br>3 = Bar (B)<br>4 = Metres (M)<br>5 = Feet (f)<br>6 = PSI (P)<br>Example: #018;3<br>sets the units to Bar                                                                                                   |
| #019   | Read unit set                                                                                                                                                                                                                                                                                   |
| #020;n | Enable / Disable unit character in the Valeport output string, where n=<br>0=hide units in Valeport string<br>1=display units in Valeport string<br>Available in the following data string formats:<br>Valeport NMEA (\$PIPS)   Valeport Standard   Valeport NMEA (\$PVIPS2)  <br>Impact SubSea |
| #021   | Read units activation status: 0 = OFF   1 = ON                                                                                                                                                                                                                                                  |

All output formats are affected by changing the output units.

## 5.7 Pressure Tare

The Interchangeable pressure sensor fitted in the miniIPS2 and 2e measures absolute pressure, that is, it includes atmospheric pressure. The pressure Tare function allows the atmospheric pressure (as measured by the sensor, normally before deployment) to be removed from the observations so the output is simply the pressure of water.

The Tare function is performed after any User Cal is applied and conversion to depth if the units selected are in feet (f) or metres (M)  
If you set the Tare in one unit it will be held in that unit until re-observed regardless of whether you change the unit subsequently

By taking a Tare reading at any fixed point in the water column, readings will then be output relative to that point

- The pressure Tare observation should be taken with the sensor in the same orientation as it will be deployed (horizontal, pointing up or pointing down) to negate any effects of the weight of the sensing element itself
  - Whilst this effect is small, it is an unnecessary contribution to the error budget

| Code          | Description                                                                                                                                                    |
|---------------|----------------------------------------------------------------------------------------------------------------------------------------------------------------|
| #007          | Enable   Disable pressure Tare function<br>#007;0 (disable)<br>#007;1 (enable)                                                                                 |
| #008          | Read pressure Tare status                                                                                                                                      |
| #009;0        | Auto Tare (observes current pressure reading and programs the Tare value)                                                                                      |
| #009;nnnn.nnn | Sets specific Tare in dBar or Bar (max resolution of 0.000001) depending on units selected by #018 command.<br>Example:<br>#009;10.325 sets tare to 10.325dBar |
| #010          | Read the current Tare value in the units set at the time it was observed                                                                                       |

If the Pressure Module, units or the calibration are changed the Tare value must be re-observed

## 5.8 Set Latitude

The Latitude is required for an accurate pressure / depth conversion - the relationship is partially dependent on local gravity, which varies with distance from the equator.

Positive / negative signing for North / South of the equator is not relevant

| # Code      | Description                                                                                                            |
|-------------|------------------------------------------------------------------------------------------------------------------------|
| #135;nn.nnn | Sets the local operating latitude in decimal degrees<br>Example: #135;50.426<br>Sets latitude to 50.426° (50° 25' 34") |
| #136        | Read the Latitude set in the instrument                                                                                |

## 5.9 Standard Set Up

A customer can request a Standard Set Up script to set their instruments up in a particular manner, output instrument information, perform variance checks and set to run mode etc..

Please contact Valeport for further information

| # Code | Description                                                                                                                                      |
|--------|--------------------------------------------------------------------------------------------------------------------------------------------------|
| #999;n | Set an instrument up as specified by a script<br>Where n = your script number<br>#999;0 will set the instrument back to factory default settings |

## 5.10 Information #Codes

The following commands will cause the sensor to report back various pieces of information, as described:

| # Code | Description                                |
|--------|--------------------------------------------|
| #004   | Read the sampling rate                     |
| #006   | Read the address mode status               |
| #008   | Read Tare activation status                |
| #010   | Read Tare value                            |
| #012   | Read operating mode                        |
| #014   | Read data string output format             |
| #015   | Read the last measured observation         |
| #019   | Read calibrated units                      |
| #021   | Read unit status                           |
| #023   | Read user calibration coefficients         |
| #030   | Read number of samples for burst averaging |
| #032   | Read firmware version number               |
| #034   | Read instrument serial number              |
| #038   | Read User calibration activation status    |
| #045   | Reads the Pressure Module QR code          |
| #093   | Read PCB serial number                     |
| #136   | Read the set Latitude                      |
| #138   | Read Pressure module calibration date      |
| #200   | Read Pressure sensor serial number         |
| #202   | Read maximum transducer pressure range     |
| #210   | Read start-up message status - on/off      |
| #701   | Reads Modbus activation status             |
| #703   | Reads Modbus address                       |

## 6 Data Output Formats

The miniIPS2 and 2e have a selection of different data output formats built in, allowing easy interface to software packages and third-party instrumentation.

### 6.1 Data String Formatting

The default setting is for the unit character to be enabled

This function is only available in the following data strings:

1. Valeport Standard (default)
2. Valeport NMEA (\$PIPS)
3. Valeport NMEA (\$PVIPS2)
4. Impact SubSea

| Code   | Description                                                                                                     |
|--------|-----------------------------------------------------------------------------------------------------------------|
| #020;n | Enable   Disable the Units character<br>#020;0 Disables the Unit character<br>#020;1 Enables the Unit character |
| #021   | Read Unit character activation status                                                                           |

The default output string delimiter character is a comma ",". This may be changed to any chosen character using the command #026.

This function is only available in the following data strings:

1. Valeport CSV
2. Valeport Standard

| Code   | Description                                                                                                                                |
|--------|--------------------------------------------------------------------------------------------------------------------------------------------|
| #026;n | Set delimiter character<br>where n = the character to be used as the delimiter<br>Example: #026;/<br>sets the data string to 0009.914/dBar |
| #027   | Read the delimiter                                                                                                                         |

### 6.2 Format: Valeport CSV

This is backwards compatible with the miniIPS data string "Valeport"

| Command:          | #013;0                                                                                                                                                                                                                                                                      |       |        |                   |          |       |   |
|-------------------|-----------------------------------------------------------------------------------------------------------------------------------------------------------------------------------------------------------------------------------------------------------------------------|-------|--------|-------------------|----------|-------|---|
| Format:           | xxxx.xxx,y<CR><LF>                                                                                                                                                                                                                                                          |       |        |                   |          |       |   |
| Notes:            | <table border="1"> <thead> <tr> <th>Field</th> <th>Format</th> </tr> </thead> <tbody> <tr> <td>Pressure or Depth</td> <td>xxxx.xxx</td> </tr> <tr> <td>Units</td> <td>y</td> </tr> </tbody> </table> <p>The string data delimiter can be changed (<a href="#">#026</a>)</p> | Field | Format | Pressure or Depth | xxxx.xxx | Units | y |
| Field             | Format                                                                                                                                                                                                                                                                      |       |        |                   |          |       |   |
| Pressure or Depth | xxxx.xxx                                                                                                                                                                                                                                                                    |       |        |                   |          |       |   |
| Units             | y                                                                                                                                                                                                                                                                           |       |        |                   |          |       |   |

Output String Example

0009.996,M

0009.996,M

### 6.3 Format: Valeport (Standard)

|          |                                                                                                                                                                                                                                    |               |
|----------|------------------------------------------------------------------------------------------------------------------------------------------------------------------------------------------------------------------------------------|---------------|
| Command: | #013;7                                                                                                                                                                                                                             |               |
| Format:  | xxxx.xxx,y,z.zzz<CR><LF>                                                                                                                                                                                                           |               |
| Notes:   | <b>Field</b>                                                                                                                                                                                                                       | <b>Format</b> |
|          | Pressure or Depth                                                                                                                                                                                                                  | xxxx.xxx      |
|          | Units                                                                                                                                                                                                                              | y             |
|          | Standard Deviation*                                                                                                                                                                                                                | z.zzz         |
|          | *Standard Deviation is only calculated in <a href="#">Burst Modes</a><br>The string data delimiter can be changed ( <a href="#">#026</a> )<br>The units displayed in the string can be enabled   disabled ( <a href="#">#020</a> ) |               |

#### Output String Examples

with units

0009.996,M,0.000

0000.996,M,0.000

without units

0009.996,0.000

0000.996,0.000

### 6.4 Format: Valeport NMEA (\$PIPS)

|                                                                                        |                              |               |
|----------------------------------------------------------------------------------------|------------------------------|---------------|
| Command:                                                                               | #013;2                       |               |
| Format:                                                                                | \$PIPS,xxxx.xx,y,*zz<CR><LF> |               |
| Notes:                                                                                 | <b>Field</b>                 | <b>Format</b> |
|                                                                                        | NMEA Identifier              | \$PIPS        |
|                                                                                        | Pressure or Depth            | xxxx.xx       |
|                                                                                        | Units                        | y             |
|                                                                                        | Checksum                     | *zz           |
| The units displayed in the string can be enabled   disabled ( <a href="#">#020;n</a> ) |                              |               |

#### Output String Examples

with units (#020;1):

\$PIPS,0001.00,M\*78

\$PIPS,0001.00,M\*78

without units (#020;0):

\$PIPS,0001.00,\*19

\$PIPS,0001.00,\*19



## 6.5 Format: Valeport NMEA (\$PVIPS2)

| Command:           | #013;8                                                                                                                                                                                                                                                                                                                                                                                                                                                                               |       |        |                 |          |                    |    |               |      |          |       |      |          |       |       |            |   |          |     |
|--------------------|--------------------------------------------------------------------------------------------------------------------------------------------------------------------------------------------------------------------------------------------------------------------------------------------------------------------------------------------------------------------------------------------------------------------------------------------------------------------------------------|-------|--------|-----------------|----------|--------------------|----|---------------|------|----------|-------|------|----------|-------|-------|------------|---|----------|-----|
| Format:            | \$PVIPS2,aa,bbbb,p.ppp,d,d.ddd,y*zz                                                                                                                                                                                                                                                                                                                                                                                                                                                  |       |        |                 |          |                    |    |               |      |          |       |      |          |       |       |            |   |          |     |
| Notes:             | NMEA identifier, instrument address, serial number,pressure in dBar, d, Data in units (#018),unit Checksum                                                                                                                                                                                                                                                                                                                                                                           |       |        |                 |          |                    |    |               |      |          |       |      |          |       |       |            |   |          |     |
|                    | <table border="1"> <thead> <tr> <th>Field</th> <th>Format</th> </tr> </thead> <tbody> <tr> <td>NMEA Identifier</td> <td>\$PVIPS2</td> </tr> <tr> <td>Instrument address</td> <td>aa</td> </tr> <tr> <td>Serial number</td> <td>bbbb</td> </tr> <tr> <td>Pressure</td> <td>p.ppp</td> </tr> <tr> <td>Unit</td> <td>d (dBar)</td> </tr> <tr> <td>Depth</td> <td>d.ddd</td> </tr> <tr> <td>Depth type</td> <td>y</td> </tr> <tr> <td>Checksum</td> <td>*zz</td> </tr> </tbody> </table> | Field | Format | NMEA Identifier | \$PVIPS2 | Instrument address | aa | Serial number | bbbb | Pressure | p.ppp | Unit | d (dBar) | Depth | d.ddd | Depth type | y | Checksum | *zz |
| Field              | Format                                                                                                                                                                                                                                                                                                                                                                                                                                                                               |       |        |                 |          |                    |    |               |      |          |       |      |          |       |       |            |   |          |     |
| NMEA Identifier    | \$PVIPS2                                                                                                                                                                                                                                                                                                                                                                                                                                                                             |       |        |                 |          |                    |    |               |      |          |       |      |          |       |       |            |   |          |     |
| Instrument address | aa                                                                                                                                                                                                                                                                                                                                                                                                                                                                                   |       |        |                 |          |                    |    |               |      |          |       |      |          |       |       |            |   |          |     |
| Serial number      | bbbb                                                                                                                                                                                                                                                                                                                                                                                                                                                                                 |       |        |                 |          |                    |    |               |      |          |       |      |          |       |       |            |   |          |     |
| Pressure           | p.ppp                                                                                                                                                                                                                                                                                                                                                                                                                                                                                |       |        |                 |          |                    |    |               |      |          |       |      |          |       |       |            |   |          |     |
| Unit               | d (dBar)                                                                                                                                                                                                                                                                                                                                                                                                                                                                             |       |        |                 |          |                    |    |               |      |          |       |      |          |       |       |            |   |          |     |
| Depth              | d.ddd                                                                                                                                                                                                                                                                                                                                                                                                                                                                                |       |        |                 |          |                    |    |               |      |          |       |      |          |       |       |            |   |          |     |
| Depth type         | y                                                                                                                                                                                                                                                                                                                                                                                                                                                                                    |       |        |                 |          |                    |    |               |      |          |       |      |          |       |       |            |   |          |     |
| Checksum           | *zz                                                                                                                                                                                                                                                                                                                                                                                                                                                                                  |       |        |                 |          |                    |    |               |      |          |       |      |          |       |       |            |   |          |     |
|                    | The units displayed in the string can be enabled   disabled ( <a href="#">#020;n</a> )                                                                                                                                                                                                                                                                                                                                                                                               |       |        |                 |          |                    |    |               |      |          |       |      |          |       |       |            |   |          |     |

### Output String Examples

With units

\$PVIPS2,01,45687,10.996,d,10.988,M\*61

\$PVIPS2,01,45687,10.996,d,10.988,M\*61

Without units

\$PVIPS2,01,45687,10.996,d,10.988,\*2c

\$PVIPS2,01,45687,10.996,d,10.988,\*2c

## 6.6 Format: CSV

| Command:          | #013;1                                                                                                                                                                                                                                                                                                                                                                                                                                                                                     |       |        |      |          |      |          |                   |        |       |     |       |      |
|-------------------|--------------------------------------------------------------------------------------------------------------------------------------------------------------------------------------------------------------------------------------------------------------------------------------------------------------------------------------------------------------------------------------------------------------------------------------------------------------------------------------------|-------|--------|------|----------|------|----------|-------------------|--------|-------|-----|-------|------|
| Format:           | dd/mm/yy, hh:mm:ss, xxxx.x,0.0,00.0<CR><LF>                                                                                                                                                                                                                                                                                                                                                                                                                                                |       |        |      |          |      |          |                   |        |       |     |       |      |
| Notes:            | <table border="1"> <thead> <tr> <th>Field</th> <th>Format</th> </tr> </thead> <tbody> <tr> <td>Date</td> <td>DD/MM/YY</td> </tr> <tr> <td>Time</td> <td>HH:MM:SS</td> </tr> <tr> <td>Pressure or Depth</td> <td>xxxx.x</td> </tr> <tr> <td>Spare</td> <td>0.0</td> </tr> <tr> <td>Spare</td> <td>0.00</td> </tr> </tbody> </table> <p>The minilPS2 does not have a real time clock so the Time and Date fields are not populated. The fields are maintained for compatibility purposes</p> | Field | Format | Date | DD/MM/YY | Time | HH:MM:SS | Pressure or Depth | xxxx.x | Spare | 0.0 | Spare | 0.00 |
| Field             | Format                                                                                                                                                                                                                                                                                                                                                                                                                                                                                     |       |        |      |          |      |          |                   |        |       |     |       |      |
| Date              | DD/MM/YY                                                                                                                                                                                                                                                                                                                                                                                                                                                                                   |       |        |      |          |      |          |                   |        |       |     |       |      |
| Time              | HH:MM:SS                                                                                                                                                                                                                                                                                                                                                                                                                                                                                   |       |        |      |          |      |          |                   |        |       |     |       |      |
| Pressure or Depth | xxxx.x                                                                                                                                                                                                                                                                                                                                                                                                                                                                                     |       |        |      |          |      |          |                   |        |       |     |       |      |
| Spare             | 0.0                                                                                                                                                                                                                                                                                                                                                                                                                                                                                        |       |        |      |          |      |          |                   |        |       |     |       |      |
| Spare             | 0.00                                                                                                                                                                                                                                                                                                                                                                                                                                                                                       |       |        |      |          |      |          |                   |        |       |     |       |      |

### Output String Example

00/00/00, 00:00:00, 0010.0,0.0,0.00

00/00/00, 00:00:00, 0010.1,0.0,0.00

## 6.7 Format: Digiquartz

This format emulates the Paroscientific Digiquartz sensor output

|          |                    |            |
|----------|--------------------|------------|
| Command: | #013;4             |            |
| Format:  | *xxxxx.xxx<CR><LF> |            |
| Notes:   | Field              | Format     |
|          | Pressure or Depth  | *xxxxx.xxx |

Output String Examples

\*000199.623

\*000199.632

## 6.8 Format: Digiquartz CDL

This format emulates the Paroscientific Digiquartz CDL sensor output

|          |                            |               |
|----------|----------------------------|---------------|
| Command: | #013;5                     |               |
| Format:  | *0001+xxxx.xxxxxxx<CR><LF> |               |
| Notes:   | Field                      | Format        |
|          | Header                     | *0001         |
|          | Pressure or Depth          | +xxxx.xxxxxxx |

Output String Examples

\*0001+0010.9960251

\*0001+0010.9958134

## 6.9 Format: HYPACK

|          |                      |        |
|----------|----------------------|--------|
| Command: | #013;3               |        |
| Format:  | xxx.x 0000.0<CR><LF> |        |
| Notes:   | Field                | Format |
|          | Pressure or Depth    | xxx.x  |
|          | Spare field          | 0000.0 |

Output String Examples

009.9 0000.0

009.9 0000.0

## 6.10 Format: Impact SubSea

This format emulates the Impact Subsea sensor output

|          |                                                                                                                                                                                                                                   |          |
|----------|-----------------------------------------------------------------------------------------------------------------------------------------------------------------------------------------------------------------------------------|----------|
| Command: | #013;6                                                                                                                                                                                                                            |          |
| Format:  | \$ISDPT,dddd.ddd,u,ppp.pppp,B,tt.tt,C*zz<CR><LF>                                                                                                                                                                                  |          |
| Notes:   | Field                                                                                                                                                                                                                             | Format   |
|          | NMEA Identifier                                                                                                                                                                                                                   | \$ISDPT  |
|          | Pressure or Depth                                                                                                                                                                                                                 | xxxx.xxx |
|          | Unit                                                                                                                                                                                                                              | u        |
|          | Absolute Pressure                                                                                                                                                                                                                 | ppp.pppp |
|          | Unit                                                                                                                                                                                                                              | B (Bar)  |
|          | Temperature                                                                                                                                                                                                                       | tt.tt    |
|          | Unit                                                                                                                                                                                                                              | C        |
|          | Checksum                                                                                                                                                                                                                          | *zz      |
|          | This string is fixed length, padded with spaces as required<br>Temperature is not available in the miniIPS2 so this field is always 00.00<br>The units displayed in the string can be enabled   disabled ( <a href="#">#020</a> ) |          |

### Output String Examples

With units

\$ISDPT,0.996,M,0.1004,B,00.00,C\*2b

\$ISDPT,0.996,M,0.1005,B,00.00,C\*2a

Without units:

\$ISDPT,0.988,,0.0997,B,00.00,C\*6b

\$ISDPT,0.988,,0.0997,B,00.00,C\*6b

## 6.11 Modbus RTU over RS485

Modbus RTU as implemented in the miniIPS2 and 2e is an industry standard interface protocol that will run over RS232 or RS485.

The Baud rate is variable 4800 to 19200 with 8N1 or 8E1 framing.

This conforms to the minimum requirements of the MODBUS standard of 9600 and 19200 baud with 8E1 framing.

Full set up and operation through Modbus is outside the scope of this document, please contact Valeport for further details.

See section [Instrument Communications Setup](#) for details on how to enable Modbus

## 7 Electrical

Power GND and Signal GND are isolated.

### 7.1 Power - miniIPS 2

7 – 28V DC input (isolated)

Draws approximately 25mA at 12V DC

### 7.2 Power - miniIPS 2e

7 – 28V DC input (isolated)

Draws approximately 125mA at 12V DC

### 7.3 Wiring Information

A miniIPS2 systems are supplied with a short (50cm) lead for splicing or testing and a USB\Power cable for interface to a PC for setup.

#### 7.3.1 Serial Connection

| 6 Way Male SubConn (MCIL6M) |                                                    |
|-----------------------------|----------------------------------------------------|
| PIN                         | FUNCTION                                           |
| 1                           | RS232 GND                                          |
| 2                           | RS232 Tx (Out of sensor) or RS485A                 |
| 3                           | RS232 Rx (Into sensor) or RS485B                   |
| 4                           | +V                                                 |
| 5                           | Link to Pin 1 for RS485<br>Not Connected for RS232 |
| 6                           | Power GND                                          |

#### 7.3.2 Ethernet Connection

| WIRE TYPE /              | WIRE COLOUR  | END 1: SCDBH13FT2 SubConn  |            | FUNCTION               |
|--------------------------|--------------|----------------------------|------------|------------------------|
|                          |              | CONNECTOR                  | PIN        |                        |
| 20 AWG<br>coloured wires | BLACK        | 13 Way SubConn<br>Bulkhead | 1          | External Power (-Ve)   |
|                          | WHITE        |                            | 3          | External Power (+Ve)   |
|                          | ORANGE       |                            | 2          | Screen (Not connected) |
|                          | RED          |                            | 12         | Not connected          |
|                          | GREEN        |                            | 13         | Not connected          |
| CAT5E patch<br>cable     | WHITE/GREEN  |                            | 11         | Bi-Dir_DA+ (Rx +)      |
|                          | GREEN        |                            | 10         | Bi-Dir_DA- (Rx -)      |
|                          | WHITE/ORANGE |                            | 9          | Bi-Dir_DB+ (Tx +)      |
|                          | ORANGE       |                            | 8          | Bi-Dir_DB- (Tx -)      |
|                          | WHITE/BLUE   |                            | 7          | Bi-Dir_DC-             |
|                          | BLUE         |                            | 6          | Bi-Dir_DC+             |
|                          | WHITE/BROWN  |                            | 5          | Bi-Dir_DD+             |
| BROWN                    |              | 4                          | Bi-Dir_DD- |                        |

### 7.3.2.1 Ethernet Y lead

| END 1: 13 WAY MALE SUBCONN CONNECTOR  |     | WIRE COLOUR  | END 2: RJ45 CONNECTOR            |     | END 3: BANANA PLUG |     | FUNCTION               |
|---------------------------------------|-----|--------------|----------------------------------|-----|--------------------|-----|------------------------|
| CONNECTOR                             | PIN |              | CONNECTOR                        | PIN | CONNECTOR          | PIN |                        |
| SubConn,<br>13 way male<br>SCDBH13MBR | 1   | Black        |                                  |     | Black 4mm Plug     | 1   | -V                     |
|                                       | 3   | White        |                                  |     | Red 4mm Plug       | 1   | +V                     |
|                                       | 2   | Orange       |                                  |     |                    |     | Screen (Not Connected) |
|                                       | 4   | Brown        | RJ45 Cable<br>Mount<br>Connector | 8   |                    |     | Bi-Dir_DD-             |
|                                       | 5   | Brown/White  |                                  | 7   |                    |     | Bi-Dir_DD+             |
|                                       | 6   | Blue         |                                  | 4   |                    |     | Bi-Dir_DC+             |
|                                       | 7   | Blue/White   |                                  | 5   |                    |     | Bi-Dir_DC-             |
|                                       | 8   | Orange       |                                  | 2   |                    |     | Bi-Dir_DB- (Tx -)      |
|                                       | 9   | Orange/White |                                  | 1   |                    |     | Bi-Dir_DB+ (Tx +)      |
|                                       | 10  | Green        |                                  | 6   |                    |     | Bi-Dir_DA- (Rx -)      |
|                                       | 11  | Green/White  |                                  | 3   |                    |     | Bi-Dir_DA+ (Rx +)      |
|                                       | 12  | Red          |                                  |     |                    |     | Not Connected          |
|                                       | 13  | Green        |                                  |     |                    |     | Not Connected          |

## 8 Software - Valeport Configure App

The miniIPS2 and miniIPS2e are fully compatible with the Valeport Configure App.

Configure has a series of pages that will assist in setting up the instrument without the need for specialist knowledge and understanding of the # code system. A Terminal window is included from where individual # commands can be sent as required.

### 8.1 Interface the instrument

Connect the miniIPS2 to a suitable comm port and power.

Use the drop-down lists to select your port, baud rate and Instrument set up file as required.

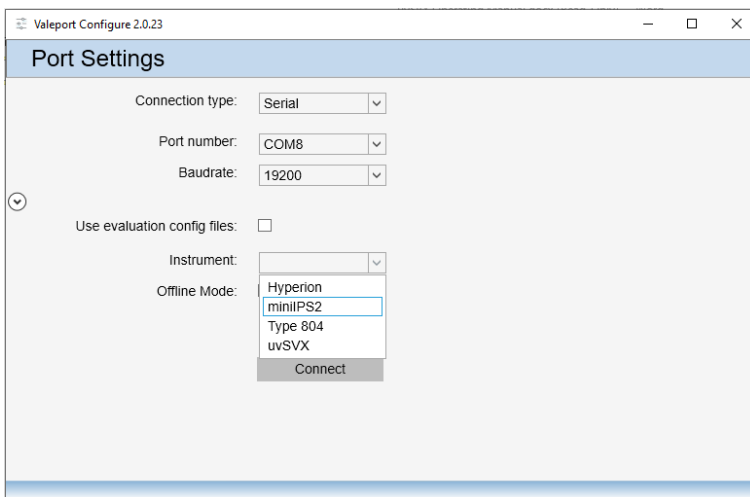

Click on the  button

#### 8.1.1 Valeport Configure Without an Instrument

If you do not have an instrument or would like to setup a configuration file to load into another instrument in preparation for a future deployment, select the tick box on the opening dialogue – Offline Mode:

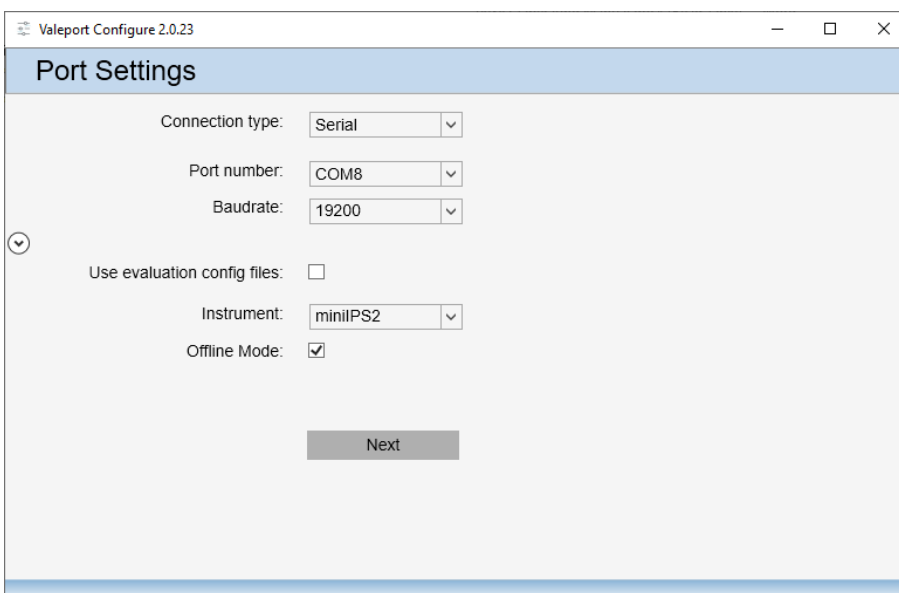

This will give you access to all the configuration options and allow you to store a configuration profile (\*.vps) file for later upload to an instrument.

Once you have prepared the Configure App configuration use the File menu to store the configuration profile

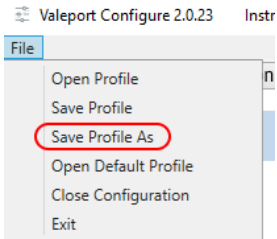

## 8.2 Configure the Instrument

The Information Tab will open. It contains read only fields that will display relevant information on the interfaced instrument

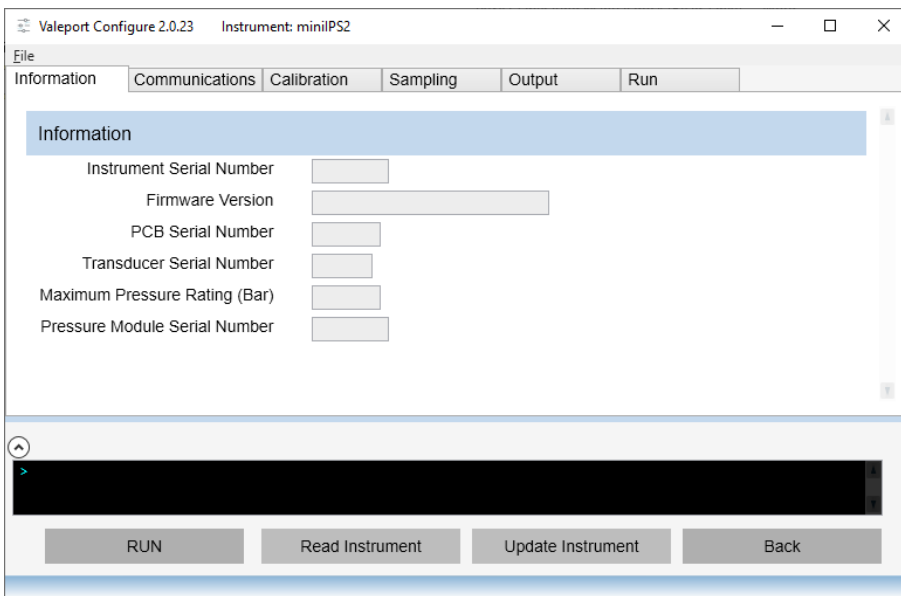

Press the **Read Instrument** button interrogate the instrument to upload all the current settings

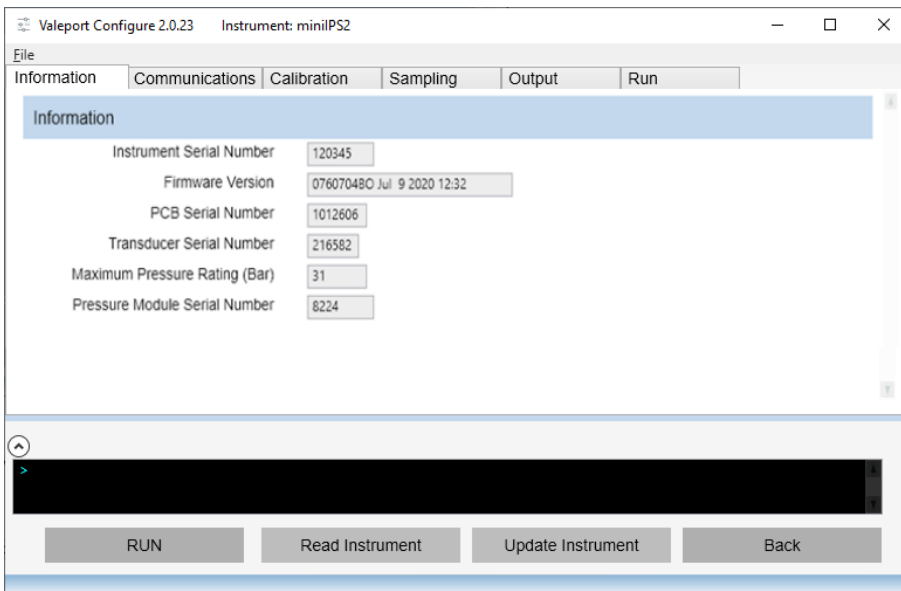

Click on the other Tabs to see relevant information and fine tune your set up, for example, Communication:

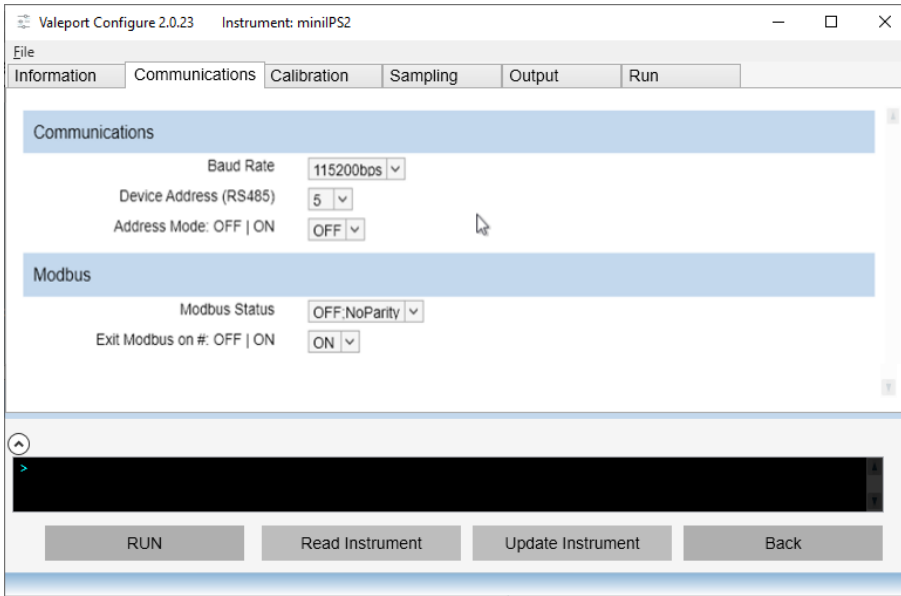

and calibration details:

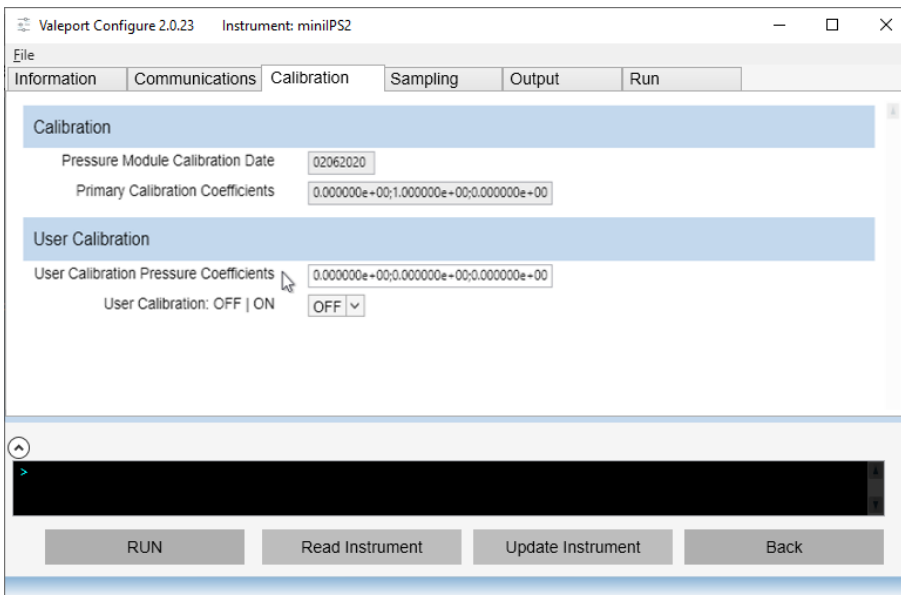



Hover over the label with your mouse to see the pop-up information window on a particular field:

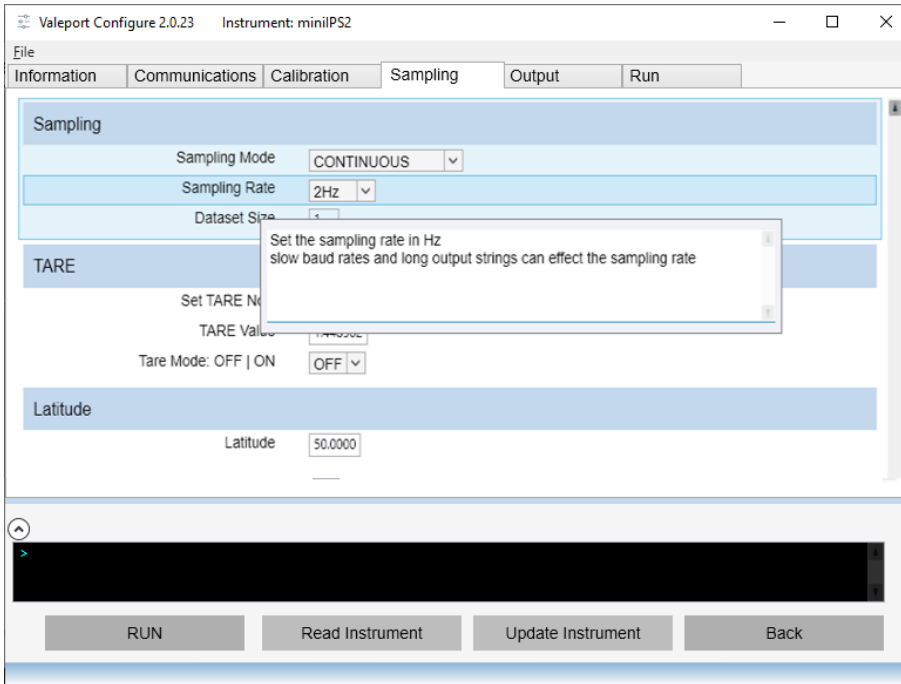

In the example below select a new Sampling Rate and the field label and will be in bold text to indicate the change.

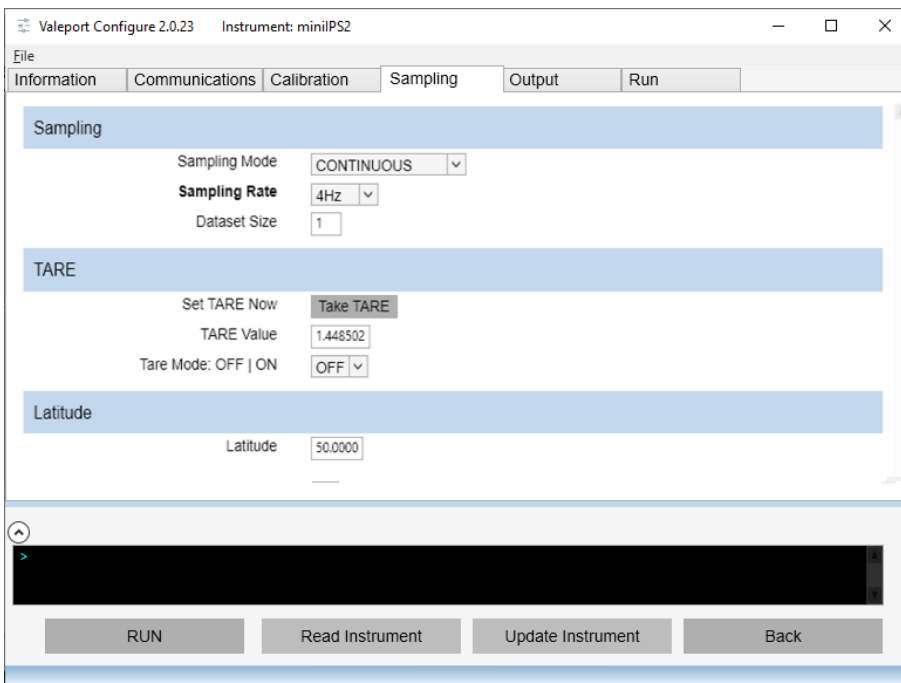

Hover over the field you have just updated to see what the current setting is in the software and what is set in the instrument (Device):

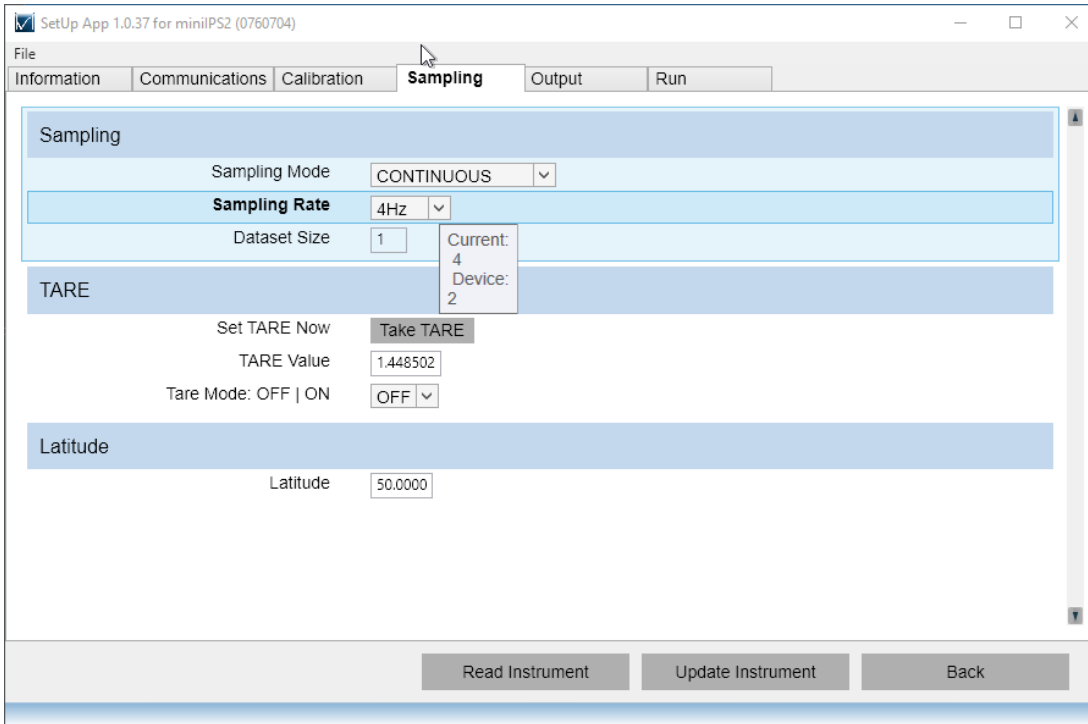

Select the Output Setup: output string, units and character display and messages

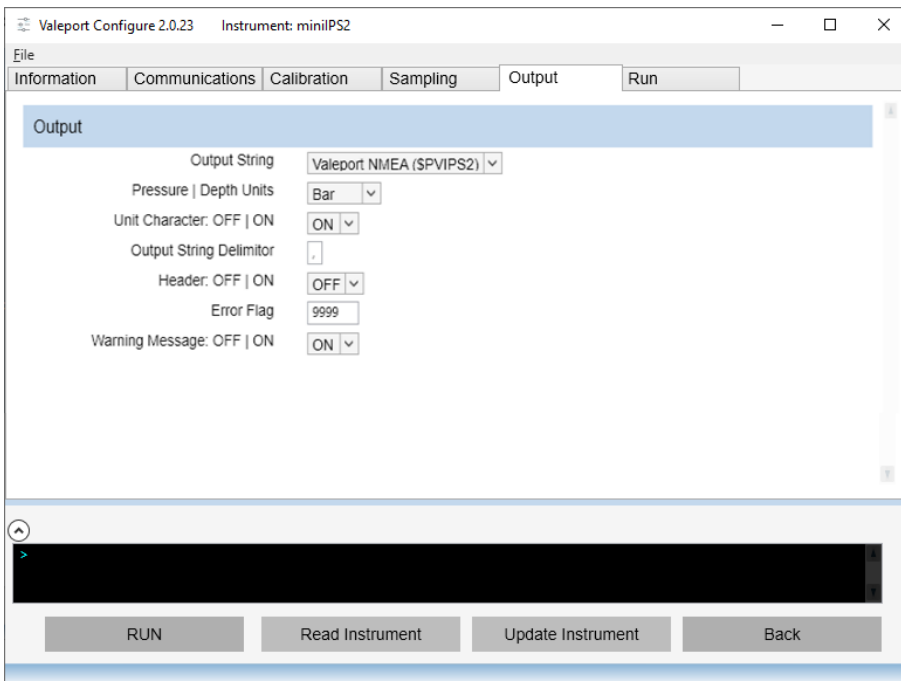

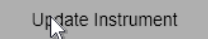
Once you have made all your changes press  to upload the new configuration into the instrument

To set the instrument into a Run Mode select the RUN tab and click on the

There is also the option to load predefined setup options, including a factory default – contact Valeport for further details if you would like a Config setting for fast setup of multiple instruments.

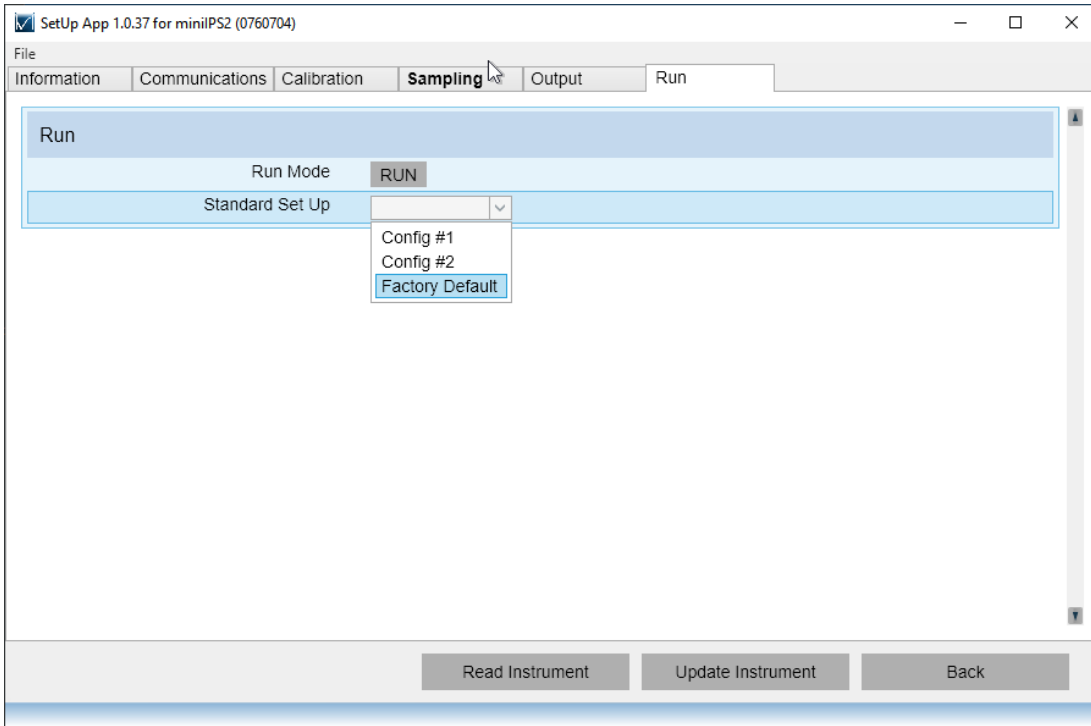

If you would like to save the configuration for future use click on the File menu (top left) and save the Profile, file. You will use the same menu to open the file into the Valeport Configure App to load into an instrument

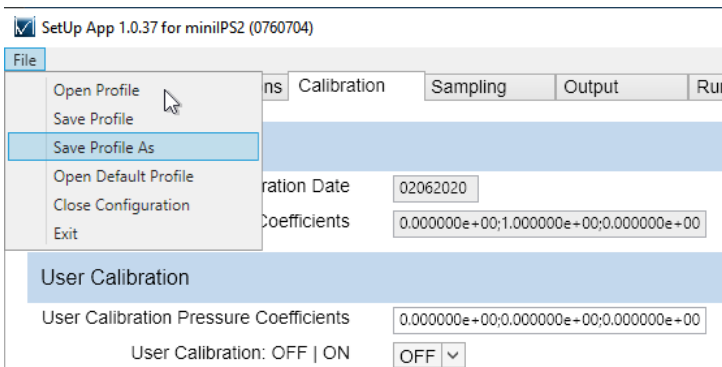

## 9 Care & Maintenance

The miniPS2 and 2e are remarkably robust, being primarily constructed of titanium. The only maintenance required, other than periodic recalibration as necessary or recommended at maximum of 2 years, is to keep the sensor as clean as possible. The instrument should be rinsed with freshwater when recovered and any debris or growth gently removed.

Do not attempt to remove the acetal Lock Screw Cap from the Pressure Module. If debris is caught under the cover attempt to remove it under slowly flowing water, use no tools. If this fails contact Valeport for further advice. If the sensor diaphragm is damaged in any way it will have to be replaced.

The instrument should be stored in its box when not in use. It is not necessary to remove the Interchangeable Pressure Sensor Module during storage.

Any damage to this diaphragm will render the Pressure Module warranty invalid

### 9.1 Calibration

The miniPS2 and 2e Interchangeable Pressure Modules can be returned to Valeport or one of its approved laboratories for recalibration.

Pressure sensors should be calibrated biennially

#### 9.1.1 Secondary Calibration

If you would like to include your own calibration use the following # codes to set it up

| # Code          | Description                                                                    |
|-----------------|--------------------------------------------------------------------------------|
| #037;n          | Enable \ Disable Secondary Calibration, where n =<br>0 = Disable<br>1 = Enable |
| #022;user_coeff | Enter user calibration coefficients as follows: #022;c2;c1;c0                  |

Contact Valeport for more details on user calibration.

## 10 Ordering and Part Numbers

| Part No.   | Description                                                                                                                                                                                                                   |
|------------|-------------------------------------------------------------------------------------------------------------------------------------------------------------------------------------------------------------------------------|
| 0760012-XX | miniIPS2 - RS232, RS485, Modbus<br>Fitted with:<br>0.01% accuracy Interchangeable piezo-resistive pressure sensor - Titanium diaphragm<br>Supplied with:<br>Interface lead<br>USB Y lead<br>Operating manual and transit case |
| 0760013-XX | miniIPS2e - Ethernet<br>Fitted with:<br>0.01% accuracy Interchangeable piezo-resistive pressure sensor - Titanium diaphragm<br>Supplied with:<br>Interface lead<br>Ethernet Y lead<br>Operating manual and transit case.      |
| PTSAXX     | Interchangeable Pressure Sensor Module (XX Bar)                                                                                                                                                                               |
| 0760089    | Pressure Module removal tool                                                                                                                                                                                                  |

XX denotes pressure transducer range - select from 10, 20, 30, 50, 100, 200, 300, 400 or 600 Bar

# 11 EU Declaration of Conformity - CE Marking

Any changes or modifications to the product or accessories supplied, that are not authorised by Valeport Ltd, could void the CE compliance of the product and negate your authority to operate it. This product has demonstrated CE compliance under conditions that include the use of shielded cables. It is important that you use shielded cables compliant with the product’s conformance, to protect from potential damage and reduce the possibility of interference to other electronic devices

## 11.1 miniIPS2

### EU Declaration of Conformity

|                               |                                         |
|-------------------------------|-----------------------------------------|
| <b>Manufacturer:</b>          | Valeport Ltd                            |
| <b>Address:</b>               | St Peter's Quay, Totnes, Devon, TQ9 5EW |
| <b>Certification marking:</b> | CE                                      |
| <b>Product Description:</b>   | miniIPS 2                               |

We the manufacturer declare that the product **miniIPS 2**, is in conformity with the following EU Directives and harmonised standard(s):

| EMC Directive 2014/30/EU | Standards                        |
|--------------------------|----------------------------------|
| EMC (Article 3.1b)       | BS EN 61326-1:2013 (Basic Level) |

| RoHS Directive 2015/863/EU | Standards            |
|----------------------------|----------------------|
| Prevention (Article 4.1)   | BS EN IEC 63000:2018 |

|                        |                          |
|------------------------|--------------------------|
| <b>Name:</b>           | D.Lakin                  |
| <b>Position:</b>       | Development Engineer     |
| <b>Place of issue:</b> | Valeport Ltd, Totnes, UK |
| <b>Date of issue:</b>  | 18 February 2020         |
| <b>Signature:</b>      |                          |

**Valeport Limited**  
St. Peter's Quay, Totnes,  
Devon TQ9 5EW UK

+44 (0) 1803 869292  
sales@valeport.co.uk  
www.valeport.co.uk

VAT No: GB 365 8753 87  
Registered in England No: 1950444

## 11.2 miniIPS2e



### EU Declaration of Conformity

|                               |                                         |
|-------------------------------|-----------------------------------------|
| <b>Manufacturer:</b>          | Valeport Ltd                            |
| <b>Address:</b>               | St Peter's Quay, Totnes, Devon, TQ9 5EW |
| <b>Certification marking:</b> | CE                                      |
| <b>Product Description:</b>   | miniIPS 2e                              |

We the manufacturer declare that the product **miniIPS 2e**, is in conformity with the following EU Directives and harmonised standard(s):

| EMC Directive 2014/30/EU | Standards                        |
|--------------------------|----------------------------------|
| EMC (Article 3.1b)       | BS EN 61326-1:2013 (Basic Level) |

| RoHS Directive 2015/863/EU | Standards            |
|----------------------------|----------------------|
| Prevention (Article 4.1)   | BS EN IEC 63000:2018 |

  

|                        |                                                                                     |
|------------------------|-------------------------------------------------------------------------------------|
| <b>Name:</b>           | D.Lakin                                                                             |
| <b>Position:</b>       | Development Engineer                                                                |
| <b>Place of issue:</b> | Valeport Ltd, Totnes, UK                                                            |
| <b>Date of issue:</b>  | 08 April 2020                                                                       |
| <b>Signature:</b>      |  |

**Valeport Limited**  
St. Peter's Quay, Totnes,  
Devon TQ9 5EW UK

+44 (0) 1803 869292  
sales@valeport.co.uk  
www.valeport.co.uk

VAT No: GB 165 8753 67  
Registered in England No. 1990444



### 11.3 Interchangeable Pressure Module



## EU Declaration of Conformity

|                               |                                               |
|-------------------------------|-----------------------------------------------|
| <b>Manufacturer:</b>          | Valeport Ltd                                  |
| <b>Address:</b>               | St Peter's Quay, Totnes, Devon, TQ9 5EW       |
| <b>Certification marking:</b> | CE                                            |
| <b>Product Description:</b>   | Interchangeable Pressure Sensor Module (IPSM) |

We the manufacturer declare that the product **Interchangeable Pressure Sensor Module (IPSM)** is in conformity with the following EU Directives and harmonised standard(s):

| EMC Directive 2014/30/EU | Standards                        |
|--------------------------|----------------------------------|
| EMC (Article 3.1b)       | BS EN 61326-1:2013 (Basic Level) |

| RoHS Directive 2015/863/EU | Standards            |
|----------------------------|----------------------|
| Prevention (Article 4.1)   | BS EN IEC 63000:2018 |

|                        |                                                                                     |
|------------------------|-------------------------------------------------------------------------------------|
| <b>Name:</b>           | James Bishop                                                                        |
| <b>Position:</b>       | Design Engineer                                                                     |
| <b>Place of issue:</b> | Valeport Ltd, Totnes, UK                                                            |
| <b>Date of issue:</b>  | 27 February 2020                                                                    |
| <b>Signature:</b>      |  |

**Valeport Limited**  
St. Peter's Quay, Totnes,  
Devon TQ9 5EW UK

+44 (0) 1803 869292  
sales@valeport.co.uk  
[www.valeport.co.uk](http://www.valeport.co.uk)

UK No. CB 165 8753 97  
Registered in England No. 1350444

